

PARTS LIST			
ITEM	QTY	PART NUMBER	DESCRIPTION
00965	1	ABA-COV-51	Valve Body Small
00893	1	ABA-COV-07 6 RINGS	Packing Ring Set
00905	1	ABA-COV-18SS	Pressure plug Stainless Steel
00964	2	ABA-COV-49	O-Ring .125" x 2.627"
00946	4	ABA-COV-32	Tie Rod
02532	2	ABA-COV-91B	SS set screws 10-32 x 7/8 inch
02157	1	ABA-COV-104	Air Cylinder Small
02054	1	169PL-4-2	1/4" Tube to 1/8" NPT Male
02053	1	68PL-4-2	Straight Connector
00896	1	ABA-COV-10	Flow Control
01605	2	ABA-COV-91	Stainless Steel Threaded Round Standoffs 1/4 OD, 2 Length, 10-32 Screw Size
01618	1	ABA-COV-90THUMBSCREW	Thumb Screw
00956	4	ABA-COV-40	Knurled Nut
00957	1	ABA-COV-44	2" S-Line Clamp
00958	1	ABA-COV-45	2" S-Line Gasket
02567	4	ABA-COV-32B	Cotter Pin
02155	1	ABA-COV-102	Pint Cone Nozzle Valve
02154	1	ABA-COV-101f	Pint Cone Nozzle with Flush
00966	1	ABA-COV-52 RevD	Valve Cap Small
02158	1	ABA-COV-105f	Pint Cone Nozzle Stem
02159	1	ABA-COV-106	Pine Cone Head Tie Plate
02156	1	ABA-COV-103 RevD	Pine Cone Bubble Breaker
02160	1	92196A110 (ABA-COV-107)	4-40 x 1/2" SHCS
02570	1	92805A245 (ABA-COV-105B)	10-24 x 3/4" FHSC Screw

PROPRIETARY AND CONFIDENTIAL
THIS INFORMATION CONTAINED IN THIS DRAWING IS THE SOLE PROPERTY OF ANTHONY BARBER ASSOCIATES, LTD (ABA). ANY REPRODUCTION IN PART OR AS A WHOLE WITHOUT THE WRITTEN PERMISSION OF ABA IS STRICTLY PROHIBITED.

UNLESS OTHERWISE SPECIFIED DIMENSIONS ARE IN INCHES		DRAWN		NAME	DATE	Anthony Barber Associates, Ltd 8041 Arrowridge Boulevard, Unit G Charlotte, NC 28273	
TOLERANCES: ANGULAR: MACH ±0.5" BEND ±1" THREE PLACE DECIMAL ±.005" TWO PLACE DECIMAL ±.01" ONE PLACE DECIMAL ±.1" INTEGER (NO DECIMAL) ±.1"		CHECKED		Simon Walker	5/12/2014	TITLE:	
FRACTIONAL ± 1/32" HOLES: Ø 0 - Ø .125 +.004/-0.002 Ø .126 - Ø .25 +.006/-0.003 Ø .251 - Ø 1 +.010/-0.005		ENG APPR.				Pint Fill Head with Flush	
MATERIAL		MFG APPR.				SIZE DWG. NO.	
FINISH		Q.A.		INTERPRET GEOMETRIC TOLERANCING PER: ASME Y14.5		REV	
NEXT ASSY	USED ON	THIRD ANGLE PROJECTION IN PART FABRICATION, BREAK EDGES & DEBURR HOLES .01 TO .02		SCALE: 1:10		WEIGHT:	
APPLICATION		DO NOT SCALE DRAWING		ABA-COV-100f		SHEET 1 OF 2	

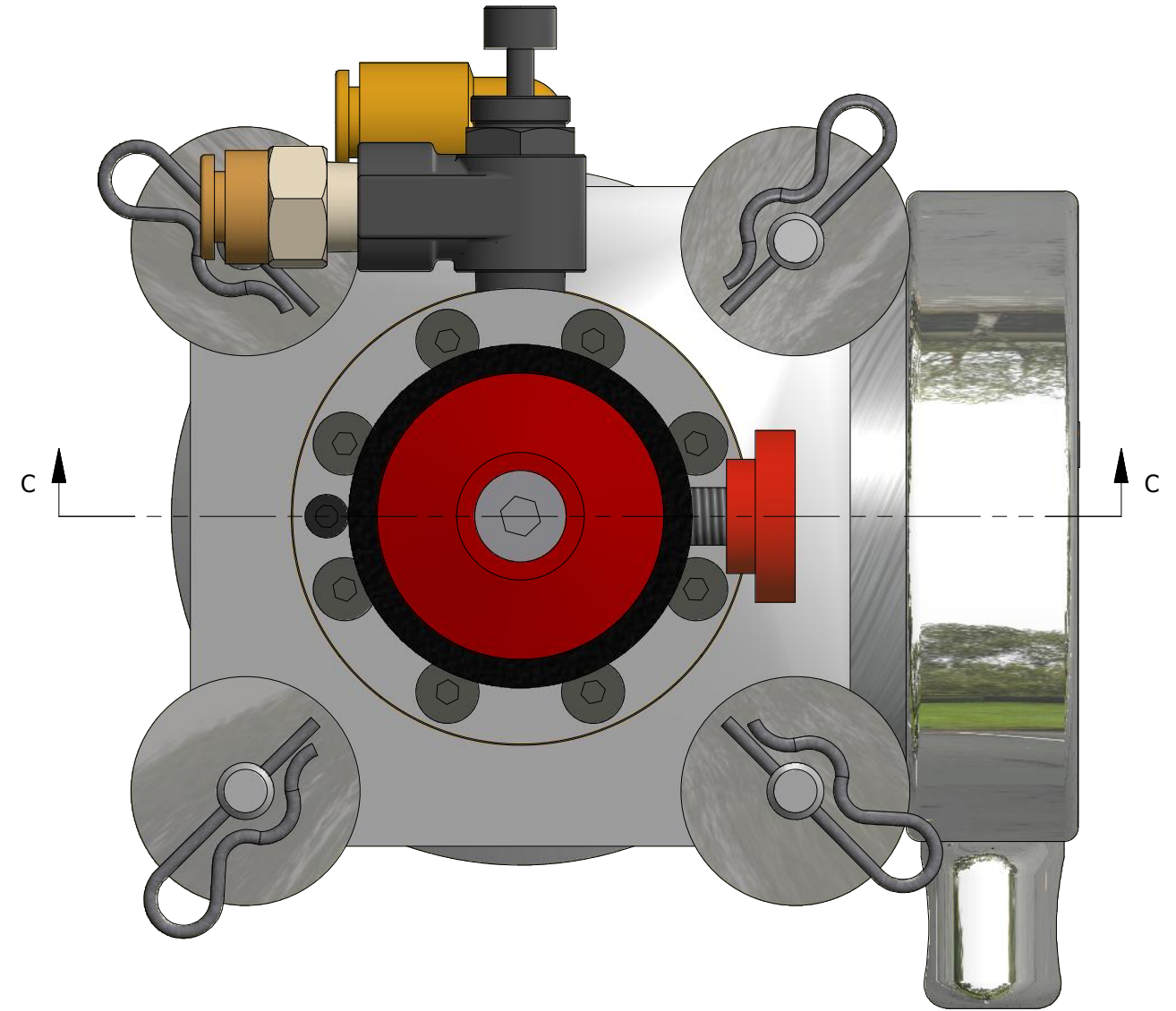

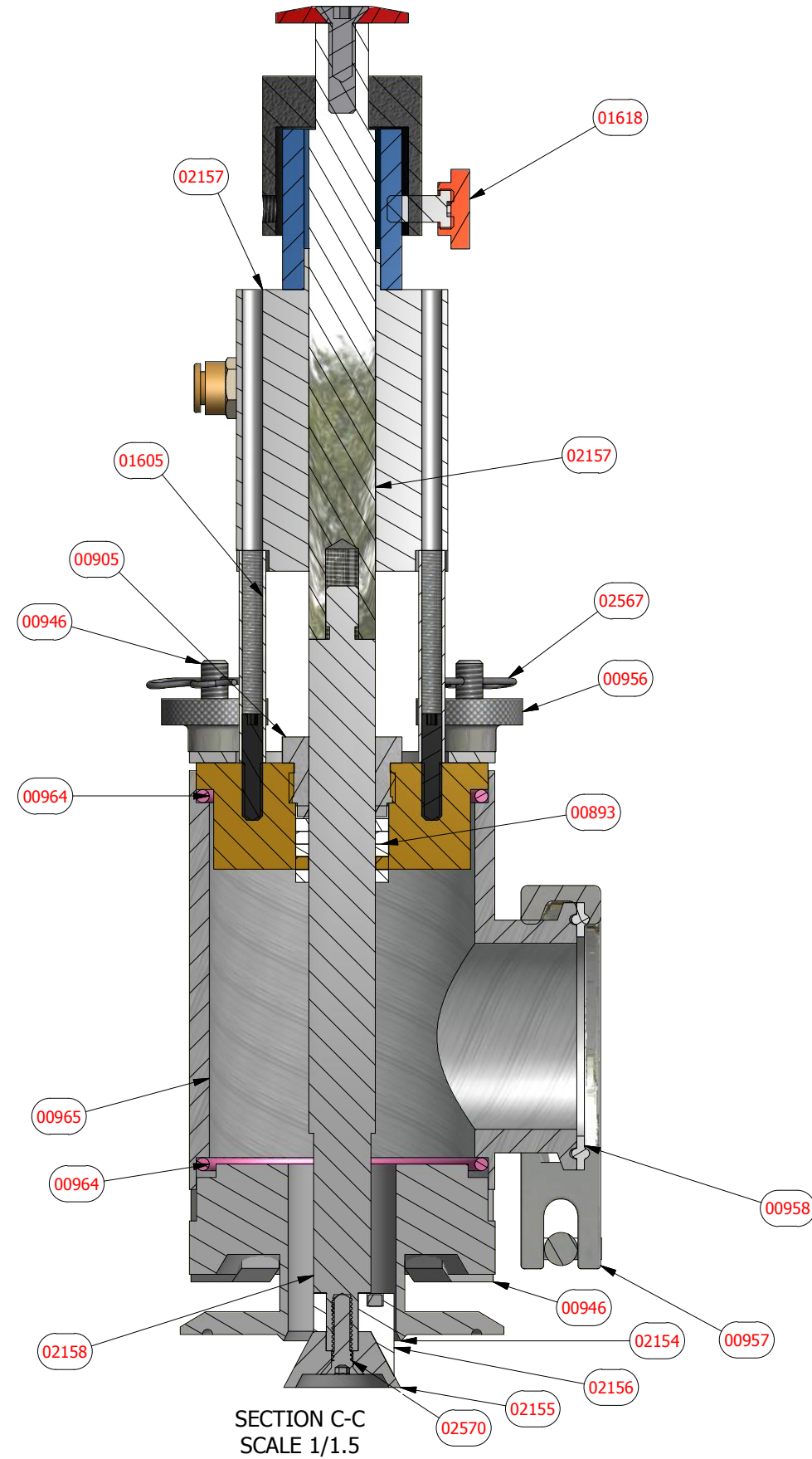





PROPRIETARY AND CONFIDENTIAL
 THIS INFORMATION CONTAINED IN THIS DRAWING IS THE SOLE PROPERTY OF ANTHONY BARBER ASSOCIATES, LTD (ABA). ANY REPRODUCTION IN PART OR AS A WHOLE WITHOUT THE WRITTEN PERMISSION OF ABA IS STRICTLY PROHIBITED.

		UNLESS OTHERWISE SPECIFIED DIMENSIONS ARE IN INCHES		DRAWN		NAME	DATE	Anthony Barber Associates, Ltd 8041 Arrowridge Boulevard, Unit G Charlotte, NC 28273		
		TOLERANCES: ANGULAR: MACH ±0.5° BEND ±1" THREE PLACE DECIMAL ±.005" TWO PLACE DECIMAL ±.01" ONE PLACE DECIMAL ±.1" INTEGER (NO DECIMAL) ±1" FRACTIONAL ± 1/32" HOLES: Ø 0 - Ø .125 +.004/-0.002 Ø .126 - Ø .25 +.006/-0.003 Ø .251 - Ø 1 +.010/-0.005		CHECKED		Simon Walker	5/12/2014	TITLE:		
		MATERIAL		ENG APPR.				Pint Fill Head with Flush		
		FINISH		MFG APPR.				SIZE DWG. NO.		
NEXT ASSY		USED ON		Q.A.		INTERPRET GEOMETRIC TOLERANCING PER: ASME Y14.5		ABA-COV-100f		
APPLICATION				THIRD ANGLE PROJECTION IN PART FABRICATION, BREAK EDGES & DEBURR HOLES .01 TO .02		SCALE: 1:10		REV		
				DO NOT SCALE DRAWING		WEIGHT:		SHEET 2 OF 2		









Anthony Barber Associates Ltd., USA
 8041 Arrowridge Boulevard, Suite G, Charlotte, NC 28273
 Tel: +1 (704) 714-3494
 Fax: +1 (704) 714-3496
<http://www.abaltd.com>
sales@abaltd.com

Bill Of Materials	
Product:	03_ABA-M320_ABA-COV-100F Pint cone nozzle assembly with flush assembly
Product Qty:	1
Customer:	
Job Number:	

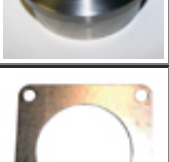
Part ID	Part Number	Qty	Description	Photo
00893 (01)	ABA-COV-07	1	Packing Ring Set, 5/8 I.D. X 7/8 O.D., 5 rings per set. (C1056 FDA compliant PTFE filament), -450f to +500f	
00964 (02)	ABA-COV-49	2	O-Ring for small cut off valve ABA-COV-48, 2 3/4inch OD, width 1/8inch, ID 2 1/2 inch Dash number 230	
02157 (03)	ABA-COV-104	1	Adjustable stroke air cylinder, pint cone head 1 1/8 inch bore x 3/4 stroke, 5/16-24 thread	
03545 (03545)	ABA-LABEL	1	ABA Label	
02162 (04)	ABA-COV-108	2	18-8 Stainless Steel Socket Head Cap Screw, 10-32 Thread, 2" Length	
02181 (05)	ABA-COV-40B	4	18-8 Stainless Steel Round Knurled Thumb Nut 1/4"-20 Screw Size, 1/2" Oall Height, 3/4" Head Dia	
02534 (06)	ABA-COV-101F	1	Nozzle with 2.5 inch flush attachment, 1.1 inch diameter outlet, pint cone head for ABA-COV-100 assembly	
02187 (06a)	ABA-COV-86SMLFADAP	1	14MPHR 2.5inch S-Line to 2.5inch hosetail adapter barbed 7 polish, 304SS (See also CB-2.5-SLINE-CLAMP and CB-2.5-SLINE-SEAL)	

				
02188 (06b)	CB-2.5-SLINE-CLAMP	1	2.5 inch S-Line Clamp, 304 SS (used with ABA-COV-86SMLFADAP)	
02189 (06c)	CB-2.5-SLINE-SEAL	1	2.5inch S-Line Teflon Seal/Gasket	
02155 (07)	ABA-COV-102	1	Valve foot, 1.1 inch diameter outlet, pint cone head for ABA-COV-100 assembly	
02156 (08)	ABA-COV-103	1	Bubble breaker, pint cone fill head for ABA-COV-100 assembly (Requires SHCS 4-40 x 1/2 P/N ABA-COV-107)	
00896 (09)	ABA-COV-10	1	Flow control, cut off valve	
00895 (10)	ABA-COV-09	2	18-8 Stainless Steel Spring Lock Washer #10 Screw Size, .200 in ID, .334 in OD, .047 in min Thk (See also/take from 92146A011 for additional inventory)	
02053 (11)	68PL-4-2	1	Straight Connector, 1/4 inch Tube x 1/8 inch NPT Male	
02054 (12)	169PL-4-2	1	Elbow 1/4inch Tube x 1/8inch NPT Male	
00905 (13)	ABA-COV-18SS	1	Pressure plug stainless steel	
02570 (14)	ABA-COV-105B	1	18-8 SS Self-Lock Flat Head Socket Cap Screw 10-24 Thread, 3/4" Length, Nylon Patch	
02533 (14)	ABA-COV-105F	1	Valve stem, pint cone head for use with flush	

				
02567 (15)	ABA-COV-32B	4	Cotter pin for ABA-COV-32	
00946 (15)	ABA-COV-32	4	Tie Rod assembly 1/4-20 thread	
00965 (16)	ABA-COV-51	1	Small valve body, ABA-COV-48 assembly, 2 inch S-line inlet.	
00966 (17)	ABA-COV-52	1	Valve cap for small cut off valve ABA-COV-48 ASSY	
02159 (18)	ABA-COV-106	1	Tie rod plate, pint cone head	
01605 (19)	ABA-COV-91	2	18-8 Stainless Steel Threaded Round Standoffs 1/4 OD, 2 Length, 10-32 Screw Size	
02532 (19)	ABA-COV-91B	2	SS Set Screws 10-32 x 7/8 inch for COV-91 Standoffs	
02160 (20)	ABA-COV-107	1	18-8 Stainless Steel Socket Head Cap Screw 4-40 Thread, 1/2" Length	
00958 (44)	ABA-COV-45	1	2inch S-Line Teflon Seal/Gasket	
00957 (45)	ABA-COV-44	1	2 inch S-Line Clamp Heavy, 304 SS	