

PARTS LIST			
ITEM	QTY	PART NUMBER	DESCRIPTION
02054	1	169PL-4-2	1/4" Tube to 1/8" NPT Male
02053	1	68PL-4-2	Straight Connector
00893	1	ABA-COV-07 6 RINGS	Packing Ring Set
00895	2	ABA-COV-09	Split Lock Washer
00896	1	ABA-COV-10	Flow Control
00905	1	ABA-COV-18SS	Pressure plug Stainless Steel
00933	1	ABA-COV-27	Valve Body
00938	1	ABA-COV-28SS	Valve Cap
00943	1	ABA-COV-31 Rev B	Tie Plate
00946	4	ABA-COV-32	Tie Rod
02567	4	ABA-COV-32B	Cotter Pin
00952	2	ABA-COV-36 - O-Ring	O-Ring 3.5 x 3.75
00956	4	ABA-COV-40	Knurled Nut
00957	1	ABA-COV-44	2" S-Line Clamp
00958	1	ABA-COV-45	2" S-Line Gasket
37	1	ABA-COV-86	Nozzle, Cone Large Style
36	1	ABA-COV-87 Rev C	Valve Foot, Large Cone Style
02750	1	ABA-COV-88-UHMWB	10-24 X 7/8 Socket Cap Screw
01574	1	ABA-COV-88UHMW	Bubble Breaker Cone Nozzle
02627	1	ABA-COV-89B - 10-24 x 1 SS	Flat Head Socket Cap Screw
01712	1	ABA-COV-89Rev D	Cutoff Valve, Valve Stem Cone Style
01604	1	ABA-COV-90	Air Cylinder Large, 1 5/8" Bore x 1" Adjustable Stroke
01618	1	ABA-COV-90THUMBSCREW	Thumb Screw
01605	2	ABA-COV-91	Stainless Steel Threaded Round Standoffs 1/4 OD, 2 Length, 10-32 Screw Size
02532	2	ABA-COV-91B	SS set screws 10-32 x 7/8 inch
01620	2	ABA-COV-92	Soc Head Cap Screw

PROPRIETARY AND CONFIDENTIAL  
 THIS INFORMATION CONTAINED IN THIS DRAWING IS THE SOLE PROPERTY OF ANTHONY BARBER ASSOCIATES, LTD (ABA). ANY REPRODUCTION IN PART OR AS A WHOLE WITHOUT THE WRITTEN PERMISSION OF ABA IS STRICTLY PROHIBITED.

UNLESS OTHERWISE SPECIFIED DIMENSIONS ARE IN INCHES		DRAWN: Simon Walker 6/13/2014		NAME: DATE:		Anthony Barber Associates, Ltd 8041 Arrowridge Boulevard, Unit G Charlotte, NC 28273	
TOLERANCES: ANGULAR: MACH ±0.5° BEND ±1° THREE PLACE DECIMAL ±.005" TWO PLACE DECIMAL ±.01" ONE PLACE DECIMAL ±.1" INTEGER (NO DECIMAL) ±1"		CHECKED:		ENG APPR:		TITLE: <b>Gallon Cone Style Fill Head</b>	
FRACTIONAL ± 1/32" HOLES: Ø 0 - Ø .125 +.004/- .002 Ø .126 - Ø .25 +.006/- .003 Ø .251 - Ø 1 +.010/- .005		MFG APPR:		Q.A.		SIZE DWG. NO. REV	
MATERIAL:		INTERPRET GEOMETRIC TOLERANCING PER: ASME Y14.5		THIRD ANGLE PROJECTION		SCALE: 1:10 WEIGHT:	
FINISH:		IN PART FABRICATION, BREAK EDGES & DEBURR HOLES: .01 TO .02		DO NOT SCALE DRAWING		ABA-COV-85 SHEET 1 OF 2	
NEXT ASSY USED ON APPLICATION							

4

3

2

1

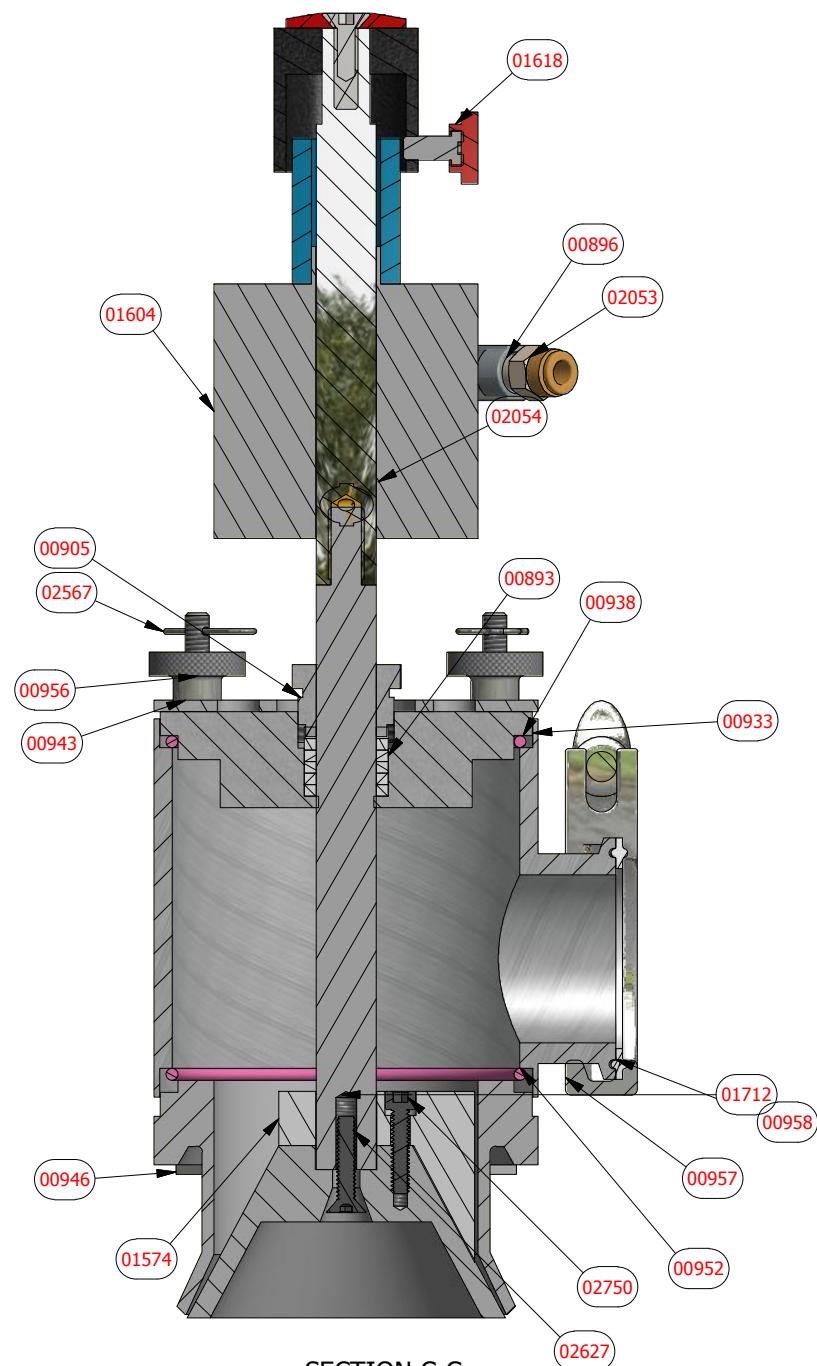

SECTION C-C  
SCALE 1/2

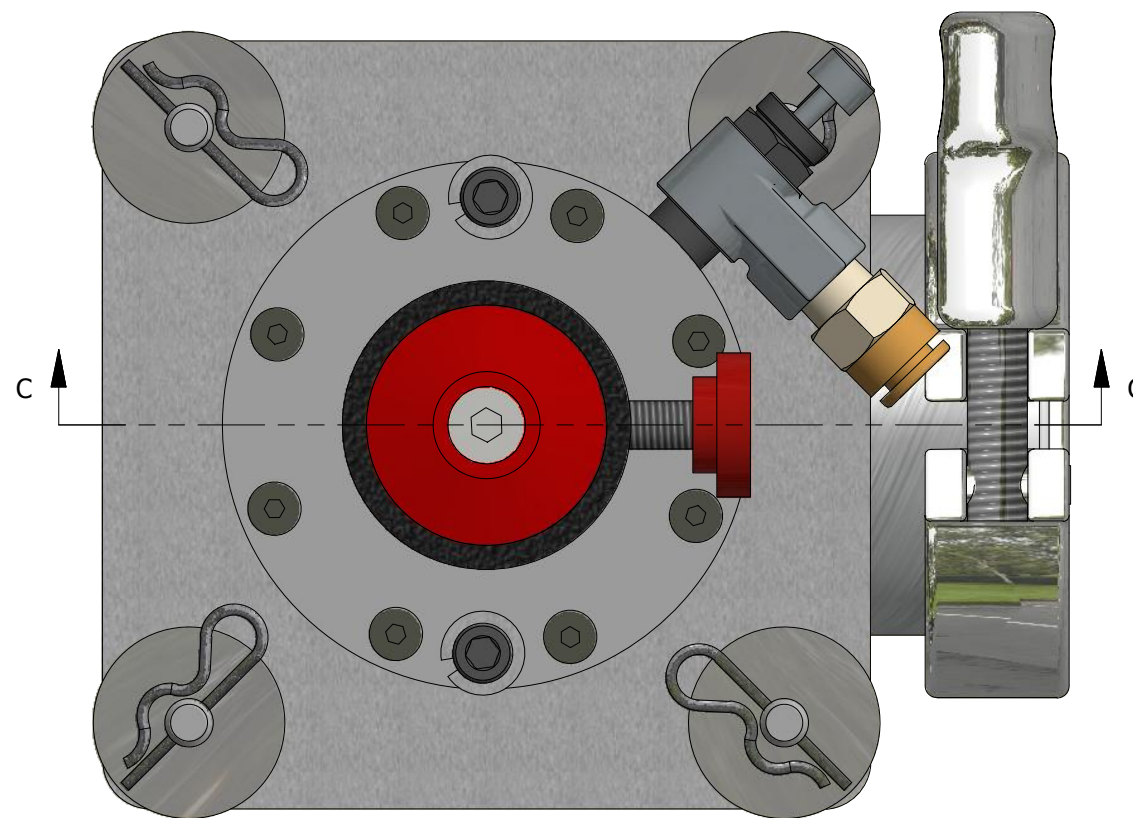

PROPRIETARY AND CONFIDENTIAL  
THIS INFORMATION CONTAINED IN THIS DRAWING IS THE SOLE PROPERTY OF ANTHONY BARBER ASSOCIATES, LTD (ABA). ANY REPRODUCTION IN PART OR AS A WHOLE WITHOUT THE WRITTEN PERMISSION OF ABA IS STRICTLY PROHIBITED.

		UNLESS OTHERWISE SPECIFIED DIMENSIONS ARE IN INCHES		NAME	DATE	Anthony Barber Associates, Ltd 8041 Arrowridge Boulevard, Unit G Charlotte, NC 28273	
		TOLERANCES: ANGULAR: MACH ±0.5° BEND ±1° THREE PLACE DECIMAL ±.005" TWO PLACE DECIMAL ±.01" ONE PLACE DECIMAL ±.1" INTEGER (NO DECIMAL) ±.1" FRACTIONAL ± 1/32" HOLES: Ø 0 - Ø .125 +.004/-0.002 Ø .126 - Ø .25 +.006/-0.003 Ø .251 - Ø 1 +.010/-0.005	DRAWN	Simon Walker	6/13/2014	TITLE: <b>Gallon Cone Style Fill Head</b>	
		MATERIAL	CHECKED			SIZE	DWG. NO.
		FINISH	ENG APPR.			B	ABA-COV-85
			MFG APPR.			SCALE: 1:10	WEIGHT:
			Q.A.				SHEET 2 OF 2
			INTERPRET GEOMETRIC TOLERANCING PER: ASME Y14.5				
			THIRD ANGLE PROJECTION				
			IN PART FABRICATION, BREAK EDGES & DEBURR HOLES: .01 TO .02				
			DO NOT SCALE DRAWING				
NEXT ASSY	USED ON						
APPLICATION							

B

B

A

A

4

3

2

1



**Anthony Barber Associates Ltd., USA**

8041 Arrowridge Boulevard, Suite G, Charlotte, NC 28273

Tel: +1 (704) 714-3494





Fax: +1 (704) 714-3496

<http://www.abaltd.com>







[sales@abaltd.com](mailto:sales@abaltd.com)

## Bill Of Materials

<b>Product:</b>	03_ABA-00006988C_ABA-COV-85 Cone Fill Head, 2 Inlet (S-Line), 3.32 Outlet, For 5 Gallon Pails.
<b>Product Qty:</b>	6
<b>Customer:</b>	
<b>Job Number:</b>	

Part ID	Part Number	Qty	Description	Photo
00893 (01)	ABA-COV-07	6	Packing Ring Set, 5/8 I.D. X 7/8 O.D., 5 rings per set.C1056	
00895 (10)	ABA-COV-09	12	18-8 Stainless Steel Spring Lock Washer #10 Screw Size, .200 in ID, .334 in OD, .047 in min Thk (See also/take from 92146A011 for additional inventory)	
00896 (09)	ABA-COV-10	6	Flow control, cut off valve	
00905 (13)	ABA-COV-18SS	6	Pressure plug stainless steel	
00933 (16)	ABA-COV-27	6	Valve body - S-line inlet	
00938 (17)	ABA-COV-28SS	6	Valve Cap COV-26 Assy, Stainless Steel	
00943 (18)	ABA-COV-31	6	Tie plate, ABA-COV-26 ASSY	

00946 (15)	ABA-COV-32	24	Tie Rod assembly 1/4-20 thread	
00952 (02)	ABA-COV-36	12	Fill head O-Ring Teflon outer, silicone core o-ring (TFE)	
00956 (05)	ABA-COV-40	24	Knurled nut 1/4-20	
00957 (21)	ABA-COV-44	6	2 inch S-Line Clamp Heavy, 304 SS	
00958 (20)	ABA-COV-45	6	2inch S-Line Teflon Seal/Gasket	
01574 (08)	ABA-COV-88UHMW	6	UHMW Bubble Breaker for Gallon Nozzle	
01604 (03)	ABA-COV-90	6	Air cylinder, 1 5/8 bore x 1inch adjustable extend stroke, 3/8-24 female thread	
01605 (19)	ABA-COV-91	12	18-8 Stainless Steel Threaded Round Standoffs 1/4 OD, 2 Length, 10-32 Screw Size	
01620 (04)	ABA-COV-92	12	18-8 Stainless Steel Socket Head Cap Screw 10-32 Thread, 2-3/4 Length for ABA-COV-85 cone head assy.	
01687 (06)	ABA-COV-86	6	Nozzle, 3.32 inch outlet, Gallon Cone Head, COV-85-ASSY	
01691 (07)	ABA-COV-87	6	Valve foot, 3.32 inch outlet, gallon cone nozzle, ABA- COV-85-ASSY	

01712 (14)	ABA-COV-89	6	Valve stem gallon cone, 3/8-24 male thread, 1/4-28 female O/E	
02053 (11)	68PL-4-2	6	Straight Connector, 1/4 inch Tube x 1/8 inch NPT Male	
02054 (12)	169PL-4-2	6	Elbow 1/4 inch Tube x 1/8inch NPT Male	
02532 (19)	ABA-COV-91B	12	SS Set Screws 10-32 x 7/8" for COV-91 Standoffs	
02567 (15)	ABA-COV-32B	24	Cotter pin for ABA-COV-32	
02627 (22)	ABA-COV-89B	6	18-8 Stainless Steel Flat Head Sckt Cap Screw 1/4-28 Thread, 1 inch Length	
02750 (08)	ABA-COV-88UHMWB	6	10-24 X 7/8 Socket Cap Screw for ABA-COV-88UHMW	
03545	ABA-LABEL	6	ABA Label	