

ITEM	QTY	PART NUMBER	DESCRIPTION
1	1	ABA-5GALL-01	Five Gallon Air Motor - Replaced with P/N ABA-PMTR-06X08R1
2	2	ABA-5GALL-02	Piston Cup
3	1	ABA-5GALL-03	Wear Ring
4	2	ABA-5GALL-04	End Seal Pump Cylinder
5	6	ABA-5GALL-05	Packing
6	1	ABA-5GALL-06	Sleeve Gland Packing
8	2	ABA-BRKT-013	1 Gallon Pump Mounting Bracket
9	2	ABA-5GALL-09	Teflon Encapsulated Silicone O-Ring Replaced with P/N ABA-5GALL-09B
10	4	ABA-5GALL-10	I-Line Gasket - Replaced with P/N ABA-5GALL-10-FEP
11	1	ABA-5GALL-11B	Male Coupling
12	2	ABA-5GALL-12	Stainless Steel Hex Nut
16	6	ABA-5GALL-16	SHCS 5-16-18UNC x .75 Long
19	2	ABA-5GALL-19	1/2-13 x 2 (90298A802)
20	1	ABA-5GALL-20	Piston
21	1	ABA-5GALL-21	Spacer
22	1	ABA-5GALL-22	Support Disk
23	1	ABA-5GALL-23	Cylinder Body 5 Gallon
30	4	ABA-5GALL-30	Check Valve
31	2	ABA-5GALL-31	Check Valve Seat
32	1	ABA-5GALL-32	Packing Gland
35	1	ABA-5GALL-48	Crank Shaft
36	1	ABA-5GALL-36-RevD	Cylinder Mount Plate
37	1	ABA-5GALL-37	Stop Plate
38	2	ABA-5GALL-38B	Stop Screw
39	1	60265K25	6 In. Hand Wheel
40	1	ABA-5GALL-40	Stop Bar
41	1	ABA-5GALL-41	Target
42	1	ABA-5GALL-42-RevC	Pump Stroke Proximity Sensor Bracket
43	1	ABA-5GALL-43	Valve Bracket
45	3	ABA-5GALL-45	SPROCKET
46	2	ABA-5GALL-46	Idler Sprocket
47	2	ABA-5GALL-47	Spacer
48	2	91247A634	Screw 3/8"-16 x 2-1/2" HHCS
49	5	ABA-5GALL-49	SLEEVE BEARING
50	1	ABA-5GALL-50	#35 Chain - Replaced with P/N ABA-PRESS-04
52	1	ABA-5GALL-52 REVb	Female Coupling
53	2	ABA-5GALL-53B	Bearing Plate
54	2	ABA-5GALL-54 REVb	Nut Plate
55	8	92240A628	18-8 SS Fully Threaded Hex Head Cap Screw 3/8-16 Thread, 1-1/2 Length
56	1	ABA-5GALL-COVERTOP	5 Gallon Volumetric Pump Top Cover
56	1	ABA-5GALL-COVERENDb	5 Gallon Volumetric Pump End Cover Part B
56	1	ABA-5GALL-COVERENDA	5 Gallon Volumetric Pump End Cover Part A
60	8	92949A541	
61	2	ABA-5GALL-61	3/4-1/2 (50785K71)
61	2	92865A580	5/16"-18 x 5/8" HHC Screw
62	4	94875A315	Teflon Spacer .5 in. dia.
65	1	ABA-5GALL-65	End Cap Front 5 Gallon Pump
66	1	ABA-5Gall-66	End CapBack 5 Gallon Pump
67	2	ABA-5GALL-67	Elbow
68	2	ABA-5GALL-68	Tee
81	1	ABA-5GALL-81	End Plate
82	2	ABA-5GALL-82	Tie Rod Shaft
83	1	ABA-5GALL-83	Tensioner Plate
84	1	ABA-5GALL-84	Center Bearing Button
85	1	ABA-85-31 REV1	Tensioner Rod
86	4	ABA-5GALL-86	4" I-Line Clamp
88	2	ABA-5GALL-88	Manifold Tube
90	2	ABA-5GALL-90E	3in. Clamp Ferrule
91	4	ABA-5GALL-91	Tied Rod
92	1	ABA-5GALL-92	Pointer
99	1	CB-3-SLINE-CLAMPa	Wing Nut
99	1	CB-3-SLINE-CLAMP	Pin
99	1	CB-3-SLINE-CLAMPb	Clamp Body
100	1	CB-3-SLINE-SEAL	3 in. Teflon Seal
101	2	ABA-85-12	3" I-Line Clamp
121	1	ABA-85-47	1 Gallon Pump Saddle
19a	2	91845A310	18-8 Stainless Steel Hex Nut 1/2"-13 Screw Size, 3/4" Width, 7/16" Height
19a	2	91845A310	18-8 Stainless Steel Hex Nut 1/2"-13 Screw Size, 3/4" Width, 7/16" Height
19b	2	98023A033	Zinc & Yellow Grade 8 Steel Flat Washer SAE, 1/2" Screw Size, 1-1/16" OD, .09"- .18" Thk
19c	6	91475A033	18-8 Stainless Steel Split Lock Washer 1/2" Screw Size, .87" OD, .12" min Thick
32a	2	92196A585	Screw 5/16-8 x 1 1/4" SHCS
36a	4	92865A718	1-2 in. - 13 Thread 1-3-4 in. Long
36f	4	103237B07	3-8in. Lock Washer
41a	4	92949A537	1-4 in. - 20 Thread 1-2 in. Length
53a	5	92865A587	5-16 in. -18 Thread 1-1-2 in Long
53b	14	91102A030	Zinc-Plated Steel Spring Lock Washer 5/16" Screw Size, .322" Id, .583"
53c	10	90126A030	Zinc-Plated Steel Type A SAE Flat Washer 5/16" Screw Size, 11/16" OD, .05"- .08" Thick
81a	8	ABA-85-39	3-8-24 x 1.25 SHCS
1001	2	ABA-5GALL-31-UHMMW	Check Valve Spacer
1052	4	91247A630	3-8-16 Thread 1-3-4 Length

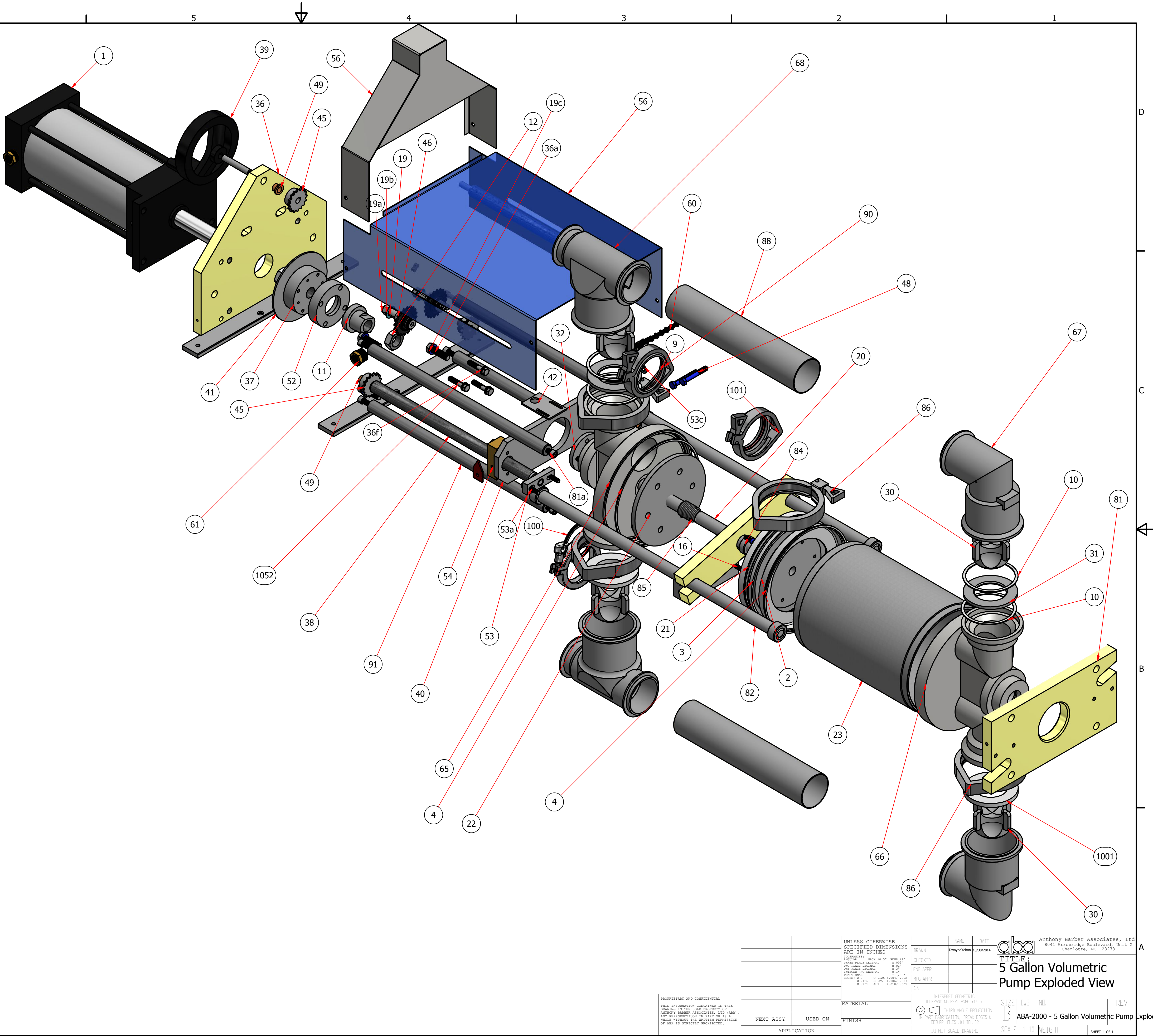

UNLESS OTHERWISE SPECIFIED DIMENSIONS ARE IN INCHES		DATE	10/20/2014
DESIGNED BY	DRW	DATE	10/20/2014
CHECKED BY	ENG APPR	DATE	
MANUFACTURED BY	MFG APPR	DATE	
ASSEMBLED BY	ASSEMBLY	DATE	
TESTED BY	TEST	DATE	
APPROVED BY	APPROVAL	DATE	
MATERIAL		FINISH	
NEXT ASSY USED ON		APPLICATION	
PROPERTY AND CONFIDENTIAL		PROPERTY AND CONFIDENTIAL	
THIS INFORMATION CONTAINED IN THIS DRAWING IS THE SOLE PROPERTY OF ANTHONY BARBER ASSOCIATES, LTD. (ABA). ALL INFORMATION IS FOR THE USE OF THE CUSTOMER AND IS NOT TO BE REPRODUCED OR TRANSMITTED IN ANY FORM OR BY ANY MEANS WITHOUT THE WRITTEN PERMISSION OF ABA IS EXPRESSLY PROHIBITED.		ANTHONY BARBER ASSOCIATES, LTD. 9041 Acknowledge Boulevard, Unit G Charlotte, NC 28273	
TITLE:		5 Gallon Volumetric Pump Exploded View	
SCALE:		1:10	
SHEET 1 OF 1		REV	

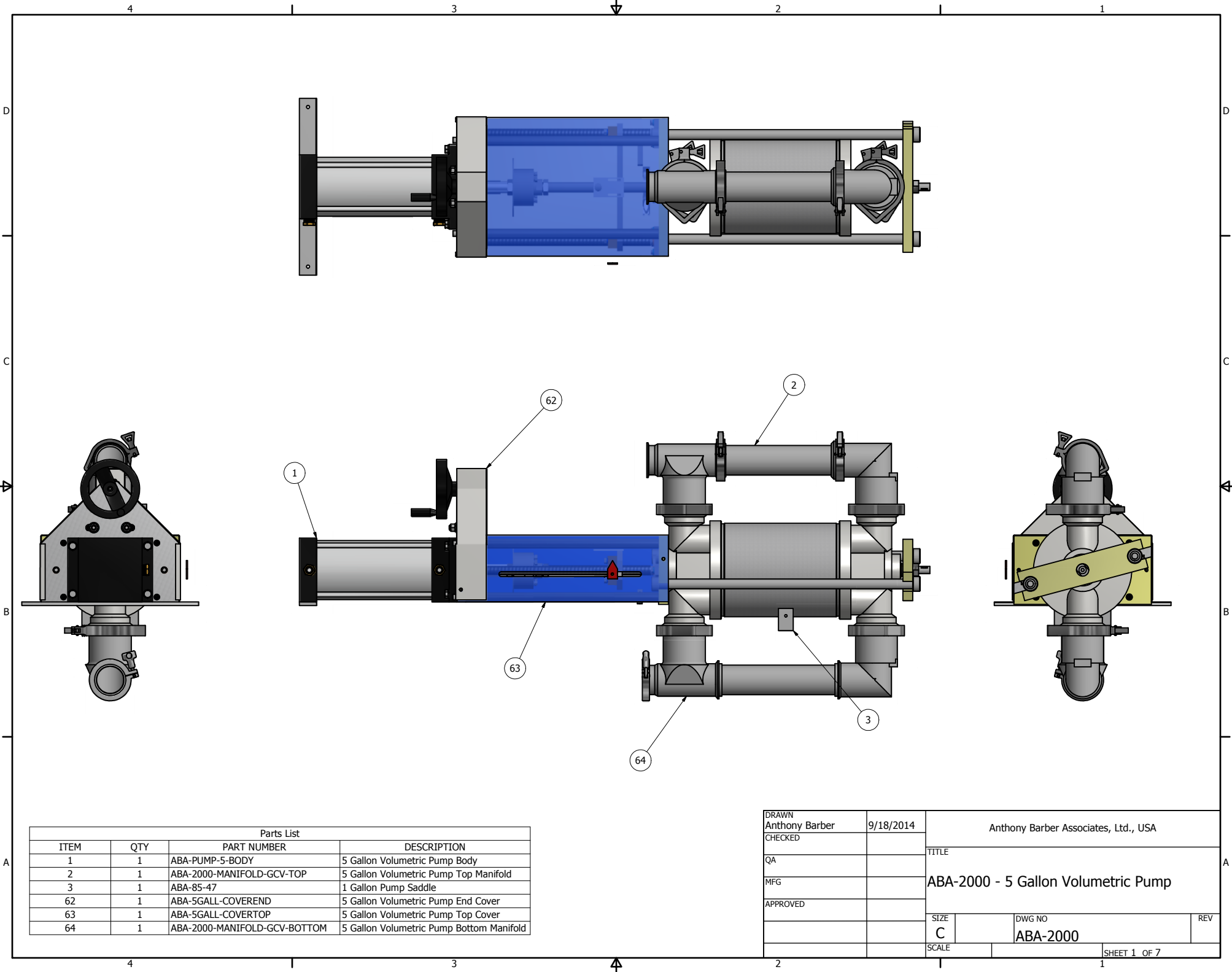

Parts List			
ITEM	QTY	PART NUMBER	DESCRIPTION
1	1	ABA-PUMP-5-BODY	5 Gallon Volumetric Pump Body
2	1	ABA-2000-MANIFOLD-GCV-TOP	5 Gallon Volumetric Pump Top Manifold
3	1	ABA-85-47	1 Gallon Pump Saddle
62	1	ABA-5GALL-COVEREND	5 Gallon Volumetric Pump End Cover
63	1	ABA-5GALL-COVERTOP	5 Gallon Volumetric Pump Top Cover
64	1	ABA-2000-MANIFOLD-GCV-BOTTOM	5 Gallon Volumetric Pump Bottom Manifold

DRAWN Anthony Barber	9/18/2014	Anthony Barber Associates, Ltd., USA	
CHECKED		TITLE	
QA		ABA-2000 - 5 Gallon Volumetric Pump	
MFG		SIZE	DWG NO
APPROVED		C	ABA-2000
		SCALE	REV
			SHEET 1 OF 7

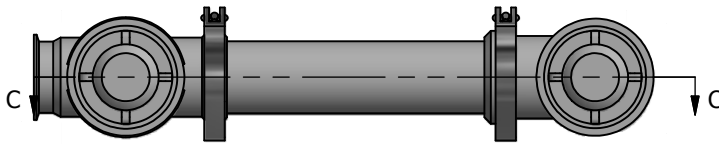
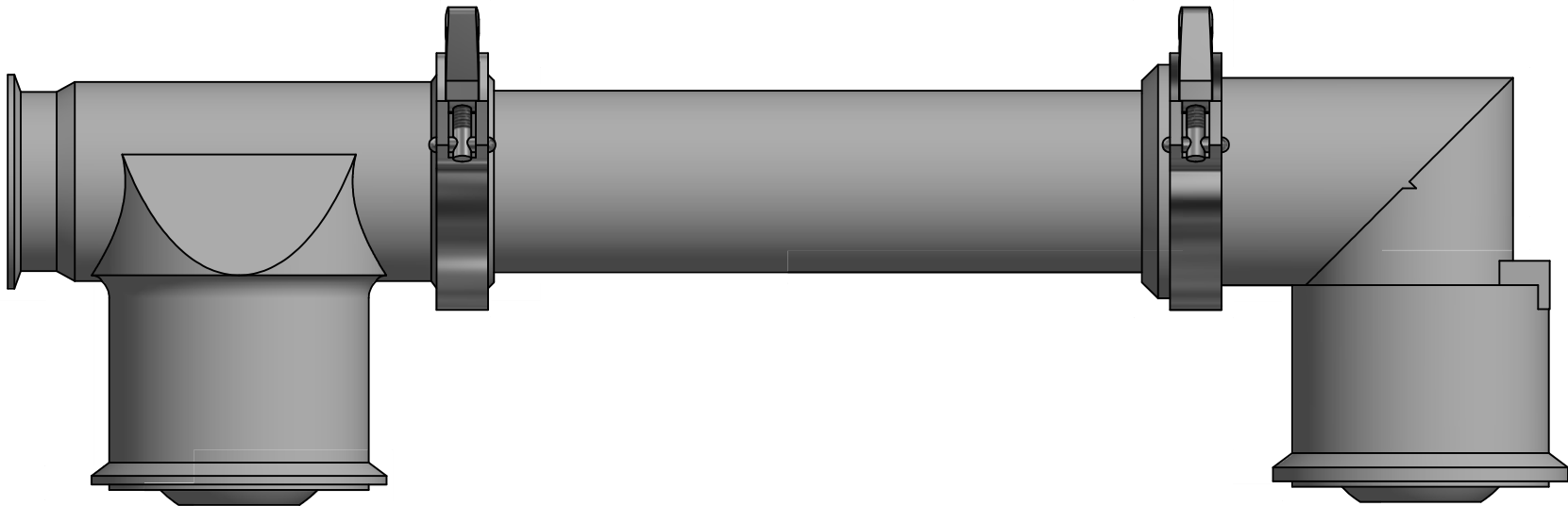

SECTION C-C
SCALE 1 / 4

Parts List			
ITEM	QTY	PART NUMBER	DESCRIPTION
7	1	ABA-5GALL-88	Manifold Tube
9	1	ABA-5GALL-68	Tee
10	1	ABA-5GALL-67	Elbow
24	2	ABA-5GALL-30	Check Valve
47	2	ABA-5GALL-09	Teflon Encapsulated Silicone O-Ring
48	2	ABA-5GALL-90E	3in. Clamp Ferrule
49	2	ABA-85-12	3" I-Line Clamp

DRAWN Anthony Barber	9/18/2014	Anthony Barber Associates, Ltd., USA	
CHECKED		TITLE	
QA		ABA-2000 - 5 Gallon Volumetric Pump	
MFG		SIZE C	DWG NO ABA-2000
APPROVED		SCALE	REV
			SHEET 6 OF 7

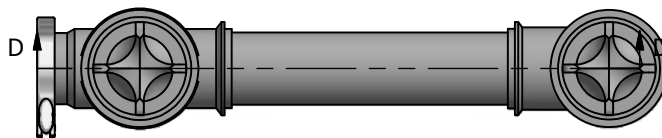
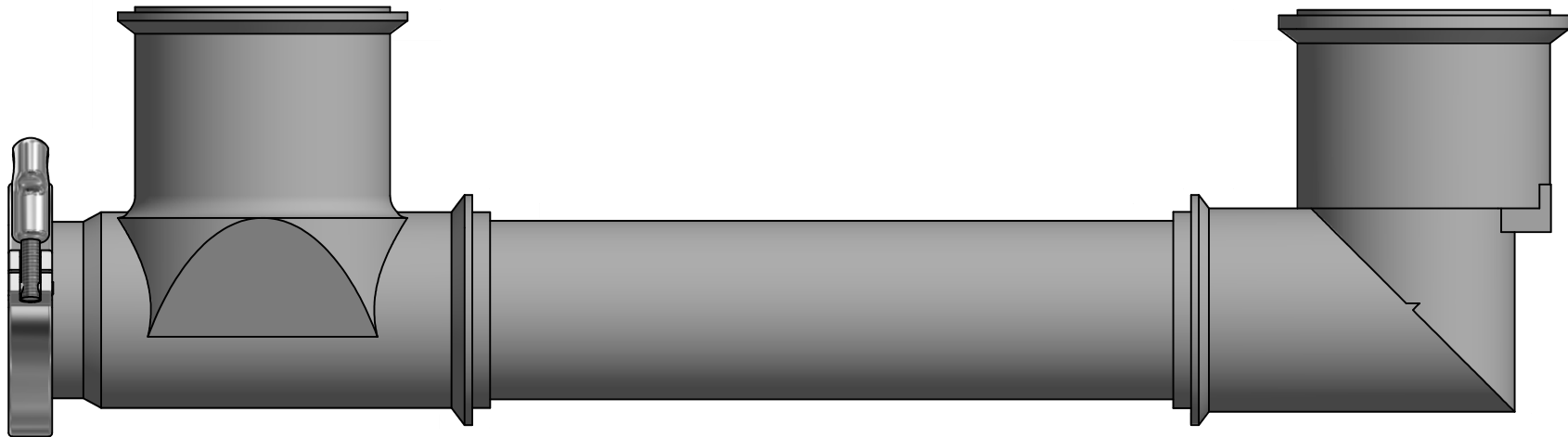

SECTION D-D
SCALE 1 / 4

Parts List			
ITEM	QTY	PART NUMBER	DESCRIPTION
7	1	ABA-5GALL-88	Manifold Tube
9	1	ABA-5GALL-68	Tee
10	1	ABA-5GALL-67	Elbow
24	2	ABA-5GALL-30	Check Valve
47	1	CB-3-SLINE-SEAL	3 in. Teflon Seal
48	1	CB-3-SLINE-CLAMP	3 In. Clamp

DRAWN Anthony Barber		9/18/2014	Anthony Barber Associates, Ltd., USA	
CHECKED			TITLE	
QA			ABA-2000 - 5 Gallon Volumetric Pump	
MFG			REV	
APPROVED			SIZE	DWG NO
			C	ABA-2000
			SCALE	SHEET 7 OF 7







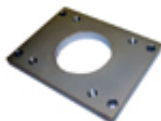

Anthony Barber Associates Ltd., USA

8041 Arrowridge Boulevard, Suite G, Charlotte, NC 28273
 Tel: +1 (704) 714-3494
 Fax: +1 (704) 714-3496
 http://www.abaltd.com
 sales@abaltd.com



Bill Of Materials

Product:	ABA-2000 Five-Gallon volumetric pump with pneumatic sensors with saddle mounting brackets and hardware and valve
Product Qty:	1
Customer:	
Job Number:	

Part ID	Part Number	Qty	Description	Photo
04080 (001)	ABA-PMTR-06X08R1	1	Air motor for 5 gallon pump, A Series, Front Flange Mount, 6 diameter x 10 inch stroke, Std rod 1.275 Rod Dia, Style 1 (1-14 Male Thds) 1/2 NPTF Port, no cushions, 1A-Rod Ext 4.0, BC Bumper Cap with SS Tie rods and SS Rod, 1/2-20 thread tie rods	
04844 (001a)	ABA-2000-MF1-FLANGE	1	Flange for air motor ABA-PMTR-06X08R1 in Plated Mild Steel - unplated replace to shelf 22-03-Right (See ABA-2000-MF1-FLANGE-MAT for material)	
00611 (002)	ABA-5GALL-02	2	5 Gallon Teflon Piston Cup	
00612 (003)	ABA-5GALL-03	1	5 Gallon Teflon Wear Ring	
00613 (004)	ABA-5GALL-04	2	5 Gallon Teflon End Seal	
00614 (005)	ABA-5GALL-05	1	5 gallon gland packing, set of six rings	
00615 (006)	ABA-5GALL-06	1	5 gallon packing gland sleeve- Teflon (1 PER)	

01592 (009)	ABA-5GALL-09B	4	3 inch ID, 3 1/4 OD, 1/8 inch width Teflon Encapsulated Silicone O-Ring (4 per)	
08105 (010)	ABA-5GALL-10-FEP	8	FEP-Encapsulated Silicone O-Ring, AS568A Dash Number 046. 1/6 inch (0.70 actual) 4.239 inch ID 4.379 inch OD	
00621 (011)	ABA-5GALL-11B	1	Male coupling, five gallon pump, 303 Stainless steel	
00622 (012)	ABA-5GALL-12	2	18-8 Stainless Steel Hex Thin (Jam) Nut 1-14 Screw Size, 1-1/2 Width, 35/64 Height	
00566 (013)	ABA-425-42C	2	Pneumatic Poppet Valve with bracket uses 2 x 92314A242 10-24 Thread, 1/2 Length Hex head screws (if used on P168 pump substitute BSF screws P/N ABA-425-48)	
02254 (014)	ABA-425-42E OVERSTROKE	1	73 spring overstroke for poppet valve. Use the 9434K95 Spring	
02141 (014b)	92141A011	2	18-8 Stainless Steel Flat Washer 10 Screw Size, 13/64 ID, 7/16 OD, .024-.038 Thk	
02762 (014c)	92146A011	2	18-8 Stainless Steel Spring Lock Washer #10 Screw Size, .200 in ID, .334 in OD, .047 in min Thk (See also/take from ABA-COV-09 for additional inventory)	
03003 (014d)	92314A242	2	18-8 Stainless Steel Hex Head Machine Screw 10-24 Thread, 1/2 Length	
00626 (016)	ABA-5GALL-16	6	5 Gallon SHCS 5/16-18UNC X .75 long 18-8 SS	
00629 (019)	ABA-5GALL-19	2	18-8 Stainless Steel Shoulder Screw 5/8" Shoulder Dia, 2" L Shoulder, 1/2"-13 Thread	
02733	91845A310	2	18-8 Stainless Steel Hex Nut 1/2-13 Screw Size, 3/4	











(019a)			Width, 7/16 Height For ABA-5GALL-19	
02832 (019b)	98023A033	4	Zinc & Yellow Grade 8 Steel Flat Washer SAE, 1/2 inch Screw Size, 1-1/16 OD, .09-.18 Thk (REPLACE with 90126A033) For ABA-5GALL-36	
02831 (019c)	91475A033	2	18-8 Stainless Steel Split Lock Washer 1/2 inch Screw Size, .87 OD, .12 min Thick (Actual McMaster Carr Part No 92146A033)	
00630 (020)	ABA-5GALL-20	1	5 Gallon piston, Shaft needs to be polished	
00631 (021)	ABA-5GALL-21	1	5 Gallon spacer piston cup.	
00632 (022)	ABA-5GALL-22	1	5 Gallon support disk, piston	
00633 (023)	ABA-5GALL-23	1	5 Gallon pump cylinder	
00640 (030)	ABA-5GALL-30	4	5 gallon check valve. These are for ABA-2000 and TF94 machined pumps, see 135473D for T95 cast pumps)	
00641 (031)	ABA-5GALL-31	4	5 Gallon valve seat, SS	
00568 (031a)	ABA-425-42E	1	Poppet Valve, Enots Replacement, No Bracket	
00642 (032)	ABA-5GALL-32	1	5 Gallon Packing Gland Nut	
02737 (032a)	92196A585	2	18-8 Stainless Steel Socket Head Cap Screw 5/16-18 Thread, 1-1/4 Length ABA-5GALL-32	

				
00646 (036)	ABA-5GALL-36	1	5 Gallon cylinder mount plate, 3/8-16 threads for mounting bar, 6061 Aluminum plate, 7/8 inch thick.	
02732 (036A)	92865A718	4	18-8 Stainless Steel Hex Head Cap Screw 1/2-13 Thread, 1-3/4 Long, Fully Threaded For ABA-5GALL-36	
02831 (036B)	91475A033	4	18-8 Stainless Steel Split Lock Washer 1/2 inch Screw Size, .87 OD, .12 min Thick (Actual McMaster Carr Part No 92146A033) For ABA-5GALL-36	
04582 (036c)	90126A033	4	18-8 Stainless Steel Type A SAE Flat Washer 1/2 Screw Size, 1-1/16 OD, .07inch-.13inch Thick For ABA-5GALL-36	
04898 (036d)	92196A363	4	18-8 Stainless Steel Socket Head Cap Screw 3/8-24 Thread, 1-1/2 Length For ABA-5GALL-36	
00223 (036f)	103237B07	4	18-8 Stainless Steel Split Lock Washer 3/8" Screw Size, .68" OD, .09" min Thick For ABA-5GALL-36	
00647 (037)	ABA-5GALL-37	1	5 Gallon stop plate (1 per pump)	
00648 (038)	ABA-5GALL-38	2	5 Gallon stop screw (2 per) 1-14UNF	
04063 (039)	60265K25	1	Spoked High Resilience Technopolymer Dished Hand Wheel Revolving Handle, 6" Wheel Diameter, 1/2" Black-oxide Steel Boss Hole Dia with 1/8" Keyway and 10-32 thread in line with keyway.	
00650 (040)	ABA-5GALL-40	1	5 Gallon stop bar SS	
00651	ABA-5GALL-41	1	5 Gallon Target (1 PER PUMP) 0.25#	

(041)				
02738 (041a)	92949A537	4	18-8 SS Button Head Socket Cap Screw 1/4-20 Thread, 1/2 inch Length For ABA-5GALL-41	
02848 (041b)	90126A029	4	18-8 Stainless Steel SAE Flat Washer 1/4 Sz, 9/32 Id, 5/8 Od, .051 Min Thk. For ABA-5GALL-41	
01127 (041c)	ABA-LINESTOP-07	8	18-8 Stainless Steel Spring Lock Washer 1/4 Screw Sz, .260 ID, .487 OD, .062 min Thick For ABA-5GALL-COVERTOP , and counter	
01628 (042)	ABA-5GALL-42	1	5 Gallon poppet valve plate (1 PER PUMP)	
00567 (042a)	ABA-425-42D	1	Pneumatic Poppet Valve bracket SUPPLY WITH 2 x 92314A242 10-24 Thread, 1/2 Length Hex head screws (if used on P168 pump substitute BSF screws P/N ABA-425-48)	
02141 (042b)	92141A011	2	18-8 Stainless Steel Flat Washer 10 Screw Size, 13/64 ID, 7/16 OD, .024-.038 Thk For Prox Brkt ABA-5GALL-42-REVB	
03003 (042c)	92314A242	2	18-8 Stainless Steel Hex Head Machine Screw 10-24 Thread, 1/2 Length For Prox Brkt ABA-5GALL-42-REVB	
02762 (042d)	92146A011	2	18-8 Stainless Steel Spring Lock Washer #10 Screw Size, .200 in ID, .334 in OD, .047 in min Thk (See also/take from ABA-COV-09 for additional inventory) For Prox Brkt ABA-5GALL-42-REVB	
00653 (043)	ABA-5GALL-43	2	5 Gallon valve bracket (2 per pump pneu, 1 per PLC)	
03015 (043a)	92240A544	2	18-8 SS Fully Threaded Hex Head Cap Screw 1/4-20 Thread, 1-1/4 Length For ABA-5GALL-43	



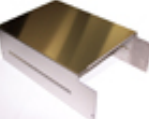

01127 (043b)	ABA-LINESTOP-07	2	18-8 Stainless Steel Spring Lock Washer 1/4 Screw Sz, .260 ID, .487 OD, .062 min Thick For ABA-5GALL-43	
00655 (045)	ABA-5GALL-45	3	5 Gallon sprocket. Steel Finished-Bore Roller Chain Sprocket for #35 Chain, 3/8" Pitch, 16 Teeth, 1/2" Bore with 1/8inch keyway machined.	
02844 (045a)	ABA-KEY-1-8-3-4	4	Plain Steel Machine Key Square Ends, Undersized, 1/8 Square, 3/4 Length	
00656 (046)	ABA-5GALL-46	2	Roller Chain Idler Sprocket Steel W/Ball Bmg, for #35 Chain, 20 Teeth,.640" Bore	
00657 (047)	ABA-5GALL-47	2	5 Gallon spacer .43 wide (2 PER PUMP)	
05384 (048)	92240A578	2	18-8 SS Fully Threaded Hex Head Cap Screw 5/16"-18 Thread, 1/2" Length	
02846 (048)	90126A030	2	Stainless Steel SAE Flat Washer 5/16 Sz, 11/32 Id, 11/16 Od,.051 For crank shaft	
02847 (048)	91102A030	2	18-8 Stainless Steel Split Lock Washer 5/16 Screw Size, .59 OD, .07 min Thick For crank shaft	
04853 (048)	ABA-5GALL-96	1	5 Gallon Pump Stroke Adjuster Crank Shaft, 0.5 Dia X 4.25 inch long, 5/16-18 Inside Threaded Both Ends, w/ 1/8 inch keyway	
04842 (048a)	DD51-AN-001.0-S-AR	1	Shaft Mounted Digital Position Counter indicator for 1/2" shaft. Orange, xx Counts per Revolution, 3.1 Display.	
04854 (048b)	ABA-BRKT-027	1	5 Gallon Pump Counter Mounting Bracket	





01125 (048c)	ABA-LINESTOP-05	2	18-8 SS Fully Threaded Hex Head Cap Screw 1/4-20 Thread, 3/4 Length For ABA-BRKT-027	
01127 (048d)	ABA-LINESTOP-07	2	18-8 Stainless Steel Spring Lock Washer 1/4 Screw Sz, .260 ID, .487 OD, .062 min Thick For ABA-BRKT-027	
02848 (048e)	90126A029	2	18-8 Stainless Steel SAE Flat Washer 1/4 Sz, 9/32 Id, 5/8 Od,.051 Min Thk.	
00659 (049)	ABA-5GALL-49	4	SAE 841 Bronze Flanged-Sleeve Bearing for 1/2" Shaft Diameter, 5/8" OD, 1/2" Length (for 5 Gallon Pump)(6 per)	
04895 (049a)	6338K421	1	SAE 841 Bronze Flanged-Sleeve Bearing for 1/2" Shaft Diameter, 5/8" OD, 1" Length (for 5 Gal pump w/counter)	
01704 (050)	ABA-PRESS-04	5	Corrosion-Resistant Steel Roller Chain #35, Single Strand, 3/8 Pitch	
01615 (051)	ABA-PRESS-05	1	35 Connecting Link for Corrosion-Resistant Steel Roller Chain	
00662 (052)	ABA-5GALL-52	1	Female coupling (1 per)	
02739 (052b)	92240A628	4	18-8 SS Fully Threaded Hex Head Cap Screw 3/8-16 Thread, 1-1/2 Length For ABA-5GALL-52	
00223 (052C)	103237B07	4	18-8 Stainless Steel Split Lock Washer 3/8" Screw Size, .68" OD, .09" min Thick For ABA-5GALL-52	
00663 (053)	ABA-5GALL-53	2	5 Gallon bearing plate(2 per)	

				
02735 (053a)	92865A587	4	18-8 Stainless Steel Hex Head Cap Screw, 5/16-18 Thread, 1-1/2 inch Long, Fully Threaded For ABA-5GALL-53 Bearing plate	
02847 (053b)	91102A030	4	18-8 Stainless Steel Split Lock Washer 5/16 Screw Size, .59 OD, .07 min Thick For ABA-5GALL-54 Bronze Bearing	
02846 (053c)	90126A030	4	Stainless Steel SAE Flat Washer 5/16 Sz, 11/32 Id, 11/16 Od, .051	
00664 (054)	ABA-5GALL-54	2	5 Gallon nut plate, 932 bearing bronze (2 per)	
02735 (054a)	92865A587	4	18-8 Stainless Steel Hex Head Cap Screw, 5/16-18 Thread, 1-1/2 inch Long, Fully Threaded For ABA-5GALL-54 Bronze Bearing	
02847 (054b)	91102A030	4	18-8 Stainless Steel Split Lock Washer 5/16 Screw Size, .59 OD, .07 min Thick For ABA-5GALL-54 Bronze Bearing	
02846 (054c)	90126A030	4	Stainless Steel SAE Flat Washer 5/16 Sz, 11/32 Id, 11/16 Od, .051 For ABA-5GALL-54 Bronze Bearing	
04459 (055)	ABA-5GALL-COVERTOP	1	5 Gallon Volumetric Pump Top Cover (Guard) Replaced with New guard with hinged cover ABA-5GALL-COVERTOP-ASSEMBLY	
04460 (056)	ABA-5GALL-COVEREND	1	5 Gallon volumetric Pump End cover (Guard)	
02738 (056a)	92949A537	4	18-8 SS Button Head Socket Cap Screw 1/4-20 Thread, 1/2 inch Length For ABA-5GALL-COVERTOP	
01127 (056b)	ABA-LINESTOP-07	4	18-8 Stainless Steel Spring Lock Washer 1/4 Screw Sz, .260 ID, .487 OD, .062 min Thick	

			For ABA-5GALL-COVERTOP	
02848 (056c)	90126A029	4	18-8 Stainless Steel SAE Flat Washer 1/4 Sz, 9/32 Id, 5/8 Od,.051 Min Thk. For ABA-5GALL-COVERTOP	
02082 (060)	169PL-8-8	2	1/2 tube x 1/2 NPT 90 degree elbow	
01669 (065)	ABA-5GALL-65	1	End cap shaft end five gallon pump	
01670 (066)	ABA-5GALL-66	1	End cap blind end, five gallon pump	
01671 (067)	ABA-5GALL-67	2	Elbow 5 Gallon pump	
01672 (068)	ABA-5GALL-68	2	Tee 5 Gallon pump	
01735 (081)	ABA-5GALL-81	1	End plate	
03094 (081a)	ABA-85-39	4	18-8 Stainless Steel Socket Head Cap Screw 3/8-24 Thread, 1-1/4 Length (4 per) For ABA-5GALL-81	
01736 (082)	ABA-5GALL-82	2	Tie rod shaft(2 per)	
01749 (083)	ABA-5GALL-83	1	Tensioner plate 303 Stainless	

01750 (084)	ABA-5GALL-84	1	Center bearing button for 5 Gallon pumps (1 per)	
00711 (085)	ABA-85-31B	1	Tensioner rod with handwheel assy. 1/2inch bore x 6inch	
01752 (086)	ABA-5GALL-86	4	4 I-line clamp (4 per)4 13IS Hvy Clamp 304	
01754 (088)	ABA-5GALL-88	2	Manifold tube cast five gallon pump, for use with gravity valves	
01756 (090)	ABA-5GALL-90	4	3 Clamp ferrule for 5 gallon pump (4 per)	
01757 (091)	ABA-5GALL-91	4	Tie Rod 3/8-24 Thread each end, 5 Gallon cast pump (4 required)	
01427 (099)	CB-3-SLINE-CLAMP	3	3 inch S-line clamp, 304 SS	
01428 (100)	CB-3-SLINE-SEAL	3	3 inch S-Line Teflon Seal/Gasket	
00688 (101)	ABA-85-12	4	3 inch I-Line Clamp CIP	
00777 (102)	ABA-ADAP-3-NPTMALE3	1	Adapter 3 inch S-Line to 3 inch NPT male	
02049 (102a)	CB-3-SLINE-ELBOW	2	3 inch S-line 90 Deg Elbow	

				
03361 (102b)	CB-3-SLINE-ELBOW45	1	45 degree 3 inch S-line elbow	
05441 (103)	07983	1	Yellow and Black Bilingual Hazard Warning Label 3-1/2" W X 5" H "CAUTION DO NOT OPERATE WITHOUT GUARDS IN POSITION" "CUIDADO NO OPERE ESTA MAQUINA SIN GUARDAS EN POSICION"	
04067 (103)	L23JJ552O000000	1	L2 Series Valve, In-Line air pilot valve, with manual overrides, 3/8 NPT ports, 3-position, open to exhaust in center position, 79 scfm @ 80psi (1674 NI/m @ 6 bar) Spring return use only on PLC controlled pumps.	
00732 (104)	ABA-85-51	2	Standard-Wall Brass Threaded Pipe Nipple 3/8 Pipe Size X 2 L, 13/32 Thrd Length, Sch 40	
03925 (104a)	50785K66	1	Med-Pressure Extruded Brass Thrd Pipe Fitting 1/2" X 3/8" Pipe Size, Male X Female Hex Bushing	
00723 (105)	ABA-85-42B	3	Exhaust Muffler 3/8 NPT Male, 24 Max SCFM, 1-1/2 Height	
00728 (121)	ABA-85-47	1	1 Gallon Pump Saddle (1 Per) - Rev B requires the 1/2-13 threads to be countersunk on the flat edge	
02742 (121b)	92210A712	2	18-8 Stainless Steel Flat Head Sckt Cap Screw 1/2-13 Thread, 1 inch Length	
03410 (121c)	ABA-CARR-547	2	1 Gallon Pump Saddle Mounting Bracket for Alluminum Extrusion, 2" x 1.5" x 1.5" 80 bracket, use 92196A581 5/16-18 x 3/4 bolts in pump saddle.	
06868 (122)	ABA-BRKT-0088	1	Pump Bracket	

				
07293 (123)	ABA-BRKT-0140	1	Pump Bracket, offset slot, wider to eliminate extrusion interference.	
06869 (124)	ABA-BRKT-0089	1	Pump Bracket	
06867 (125)	ABA-BRKT-0087	1	Pump Bracket	
03214 (125a)	92210A622	2	18-8 SS Flat Head Socket Cap Screw 3/8-16 Thread, 3/4 Length	