

PARTS LIST			
ITEM	QTY	PART NUMBER	DESCRIPTION
00893	1	ABA-COV-07 6 RINGS	
00896	1	ABA-COV-10 Real	
00905	1	ABA-COV-18SS	Pressure plug Stainless Steel
00946	4	ABA-COV-32	
00956	4	ABA-COV-40	
00957	1	ABA-COV-44	2" S-Line Clamp
00958	1	ABA-COV-45	2" S-Line Gasket
00964	2	ABA-COV-49	O-Ring .125" x 2.627"
00965	1	ABA-COV-51	Valve Body Small
00966	1	ABA-COV-52 RevD	Valve Cap Small
01605	2	ABA-COV-91	
01618	1	ABA-COV-90THUMBSCREW	
02053	1	68PL-4-2	
02054	1	169PL-4-2	1/4" Tube to 1/8" NPT Male
02154	1	ABA-COV-101	Pint Cone Nozzle
02155	1	ABA-COV-102	Pint Cone Nozzle Valve
02156	1	ABA-COV-103 RevD	Pine Cone Bubble Breaker
02157	1	ABA-COV-104	Air Cylinder Small
02158	1	ABA-COV-105	Pint Cone Nozzle Stem
02159	1	ABA-COV-106	Pine Cone Head Tie Plate
02160	1	92196A110 (ABA-COV-107)	4-40 x 1/2" SHCS
02532	2	ABA-COV-91B	
02567	4	ABA-COV-32B	
02570	1	92805A245 (ABA-COV-105B)	10-24 x 3/4" FHSC Screw

DRAWN Simon N. Walker		8/28/2008	Anthony Barber Associates, Ltd., USA	
CHECKED			TITLE	
QA			ABA-COV-100 - Pint Fill Head	
MFG			SIZE C	DWG NO ABA-COV-100
APPROVED			SCALE	REV
			SHEET 1 OF 2	

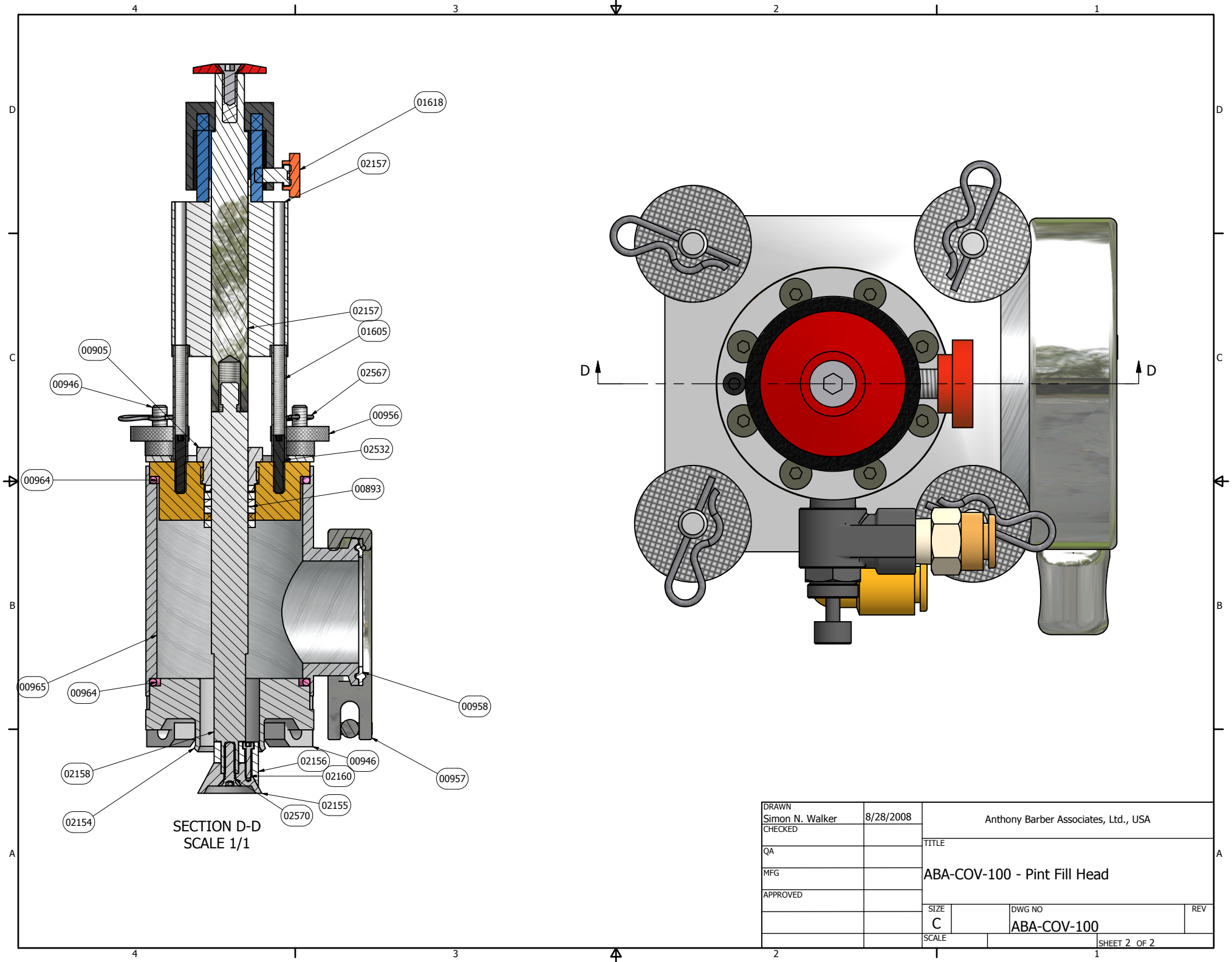

SECTION D-D
SCALE 1/1

DRAWN Simon N. Walker		8/28/2008		Anthony Barber Associates, Ltd., USA	
CHECKED				TITLE	
QA				ABA-COV-100 - Pint Fill Head	
MFG				SIZE	
APPROVED				C	
				DWG NO	
				ABA-COV-100	
				REV	
				SHEET 2 OF 2	



Anthony Barber Associates Ltd., USA

8041 Arrowridge Boulevard, Suite G, Charlotte, NC 28273

Tel: +1 (704) 714-3494











Fax: +1 (704) 714-3496

<http://www.abaltd.com>

sales@abaltd.com

Bill Of Materials	
Product:	ABA-COV-100 Pint cone style nozzle assemble, no flush.
Product Qty:	2
Customer:	
Job Number:	

Part ID	Part Number	Qty	Description	Photo
00893 (01)	ABA-COV-07	2	Packing Ring Set, 5/8" I.D. X 7/8" O.D., 5 rings per set.	
00895 (10)	ABA-COV-09	4	18-8 Stainless Steel Spring Lock Washer #10 Screw Size, .200" ID, .334" OD, .047" min Thk (See also/take from 92146A011 for additional inventory)	
00896 (09)	ABA-COV-10	2	Flow control, cut off valve	
00905 (13)	ABA-COV-18SS	2	Pressure plug stainless steel	
00946 (15)	ABA-COV-32	8	Tie Rod assembly 1/4-20 thread	
00957 (45)	ABA-COV-44	2	2inch S-Line Clamp Heavy, 2 Tri-clover, 304 SS	
00958 (44)	ABA-COV-45	2	2inch S-Line Teflon Seal/Gasket	
00964 (02)	ABA-COV-49	4	O-Ring for small cut off valve ABA-COV-48, 2 3/4inch OD, width 1/8inch, ID 2 1/2"	

00965 (16)	ABA-COV-51	2	Small valve body, ABA-COV-48 assembly	
00966 (17)	ABA-COV-52	2	Valve cap for small cut off valve ABA-COV-48 ASSY	
01605 (19)	ABA-COV-91	4	18-8 Stainless Steel Threaded Round Standoffs 1/4" OD, 2" Length, 10-32 Screw Size	
02053 (11)	68PL-4-2	2	Straight Connector, 1/4 inch Tube x 1/8 inch NPT Male	
02054 (12)	169PL-4-2	2	Elbow 1/4 inch Tube x 1/8inch NPT Male	
02154 (06)	ABA-COV-101	2	Nozzle, 1.1 inch diameter outlet, pint cone head for ABA-COV-100 assembly	
02155 (07)	ABA-COV-102	2	Valve foot, 1.1 inch diameter outlet, pint cone head for ABA-COV-100 assembly	
02156 (08)	ABA-COV-103	2	Bubble breaker, pint cone fill head for ABA-COV-100 assembly (Requires SHCS 4-40 x 1/2 P/N ABA-COV-107)	
02157 (03)	ABA-COV-104	2	Adjustable stroke air cylinder, pint cone head 1 1/8" bore x 3/4" stroke, 5/16-24 thread	
02158 (14)	ABA-COV-105	2	Valve stem, pint cone head, 5/16-24 Male thread one end, 10-24 female other end.	
02159 (18)	ABA-COV-106	2	Tie rod plate, pint cone head	
02160 (20)	ABA-COV-107	2	18-8 Stainless Steel Socket Head Cap Screw 4-40 Thread, 1/2" Length	

				
02162 (04)	ABA-COV-108	4	10-32 X 2" SS socket head cap screw for pint cone head (2 per)	
02181 (05)	ABA-COV-40B	8	18-8 Stainless Steel Round Knurled Thumb Nut 1/4"-20 Screw Size, 1/2" Oall Height, 3/4" Head Dia	
02532 (19)	ABA-COV-91B	4	SS Set Screws 10-32 x 7/8" for COV-91 Standoffs	
02567 (15)	ABA-COV-32B	8	Cotter pin for ABA-COV-32	
02570 (14)	ABA-COV-105B	2	18-8 SS Self-Lock Flat Head Socket Cap Screw 10-24 Thread, 3/4" Length, Nylon Patch	
03545	ABA-LABEL	2	ABA Label	